



DVD



MECHLESS

# XDVD251 BT

## INSTALLATION/OWNER'S MANUAL

Multimedia Receiver with Bluetooth®  
featuring a 6.2" Touch Screen Display



**USB**

**MP3**



### Safety Notes: (Only DVD Receiver)

The DVD video display of the in-dash unit will not operate while the vehicle is moving. This is a safety feature to prevent driver distraction. In-dash DVD video functions will only operate when vehicle is in Park and the parking brake is engaged. It is illegal in most states for the driver to view video while the vehicle is in motion.



## **XDVD251BT OPERATION**

---

### **⚠ WARNING ⚠**

Upon installation of this Monitor/DVD player ("unit") into a vehicle, the driver of the vehicle must not operate this unit by watching videos or playing video games while driving. Failure to follow this instruction could lead to driver distraction which could result in serious injury or death to the vehicle's occupants or persons outside the vehicle and/or property damage.

Several states prohibit the installation of monitors/DVD players if the screen is visible from the driver's seat. If you reside in a jurisdiction which has enacted such a law, this unit must not be installed so that the screen is visible from the driver's seat. When installing this unit in the front console/dashboard, the unit must be positioned so that it is facing the front passenger seat only. Failure to follow this instruction could lead to driver distraction which could result in serious injury or death to the vehicle's occupants or persons outside the vehicle and/or property damage.

This unit is designed so that it may be operated only when the vehicle is in "Park" and the parking brake is fully engaged. To this end, this unit includes a parking brake lock-out feature which prohibits the unit from operating if the vehicle is not in "Park" and/or the parking brake is not fully engaged. When installing this unit, the installer must connect the parking brake detect wire to the parking brake mechanism in order to make the parking brake lock-out feature operable. **DO NOT** simply ground the parking brake detect wire to a metal portion of the vehicle. Failure to properly install the parking brake lock-out feature could lead to driver distraction which could result in serious injury or death to the driver's occupants or persons outside the vehicle and/or property damage.

Once the parking brake lock-out feature is installed, the owner/user must not attempt to disrupt/neutralize the parking brake lock-out feature by (a) partially engaging the parking brake and/or (b) purchasing/using any device or unit designed to send necessary brake signals to the unit. Failure to follow these instructions could lead to driver distraction which could result in serious injury or death to the driver's occupants or persons outside the vehicle and/or property damage.

When operating this unit, keep the unit's volume level low enough so that the vehicle's occupants can hear traffic-related sounds such as police and emergency vehicles. Failure to follow this instruction could lead to driver distraction which could result in serious injury or death to the vehicle's occupants or persons outside the vehicle and/or property damage.

**\* Note**

The above video Content is for DVD Receiver Only.

---

## Safety Information

Please read all instructions carefully before attempting to install or operate.

Due to its technical nature, it is highly recommended that your DUAL XDVD251BT is installed by a professional installer or an authorized dealer. This product is only for use in vehicles with 12VDC negative ground only.

### To prevent damage or injury:

- Make sure to ground the unit securely to the vehicle chassis ground.
- Do not remove the top or bottom covers of the unit.
- Do not install the unit in a spot exposed to direct sunlight or excessive heat or the possibility of water splashing.
- Do not subject the unit to excessive shock.
- When replacing a fuse, only use a new one with the prescribed rating. Using a fuse with the wrong rating may cause the unit to malfunction.
- To prevent short circuits when replacing a fuse, disconnect the wiring harness first.
- Use only the provided hardware and wire harness.
- You cannot view video while the vehicle is moving. Find a safe place to park and engage the parking brake.
- If you experience problems during installation, consult your nearest DUAL dealer.
- If the unit malfunctions, reset the unit as described on page 10 first. If the problem still persists, consult your nearest DUAL dealer or call tech assistance @ 1-866-382-5476.
- To clean the monitor, wipe only with a dry silicone cloth or soft cloth. Do not use a stiff cloth, or volatile solvents such as paint thinner and alcohol. They can scratch the surface of the panel and/or remove the printing.
- When the temperature of the unit falls (as in winter), the liquid crystal inside the screen will become darker than usual. Normal brightness will return after using the monitor for a while.
- When extending the ignition, battery or ground cables, make sure to use automotive-grade cables or other cables with an area of 0.75mm (AWG 18) or more to prevent voltage drops.
- Do not touch the liquid crystal fluid if the LCD is damaged or broken. The liquid crystal fluid may be hazardous to your health or fatal. If the liquid crystal fluid from the LCD contacts your body or clothing, wash it off with soap immediately.

### FCC Compliance

This device complies with Part 15 of the FCC Rules. Operation is subject to the following two conditions:

- (1) this device may not cause harmful interference, and
- (2) this device must accept any interference received, including interference that may cause undesired operation.

**Warning:** Changes or modifications to this unit not expressly approved by the party responsible for compliance could void the user's authority to operate the equipment.

**Note:** This equipment has been tested and found to comply with the limits for a Class B digital device, pursuant to Part 15 of the FCC Rules. These limits are designed to provide reasonable protection against harmful interference in a residential installation. This equipment generates, uses and can radiate radio frequency energy and, if not installed and used in accordance with the instructions, may cause harmful interference to radio communications. However, there is no guarantee that interference will not occur in a particular installation. If this equipment does cause harmful interference to radio or television reception, which can be determined by turning the equipment off and on, the user is encouraged to try to correct the interference by one or more of the following measures:

- Reorient or relocate the receiving antenna.
- Increase the separation between the equipment and receiver.
- Connect the equipment into an outlet on a circuit different from that to which the receiver is connected.
- Consult the dealer or an experienced radio/TV technician for help.



## Preparation

### Before You Start

- Disconnect negative battery terminal. Consult a qualified technician for instructions.
- Avoid installing the unit where it would be subject to high temperatures, such as from direct sunlight, or where it would be subject to dust, dirt or excessive vibration.

### Getting Started

- Connect wiring harness as shown on page 6. Consult a qualified technician if you are unsure.
- Certain vehicles may require an installation kit and/or wiring harness adapter (sold separately).
- Reconnect negative battery terminal, and test for correct operation.
- Snap trim ring into place (if required).

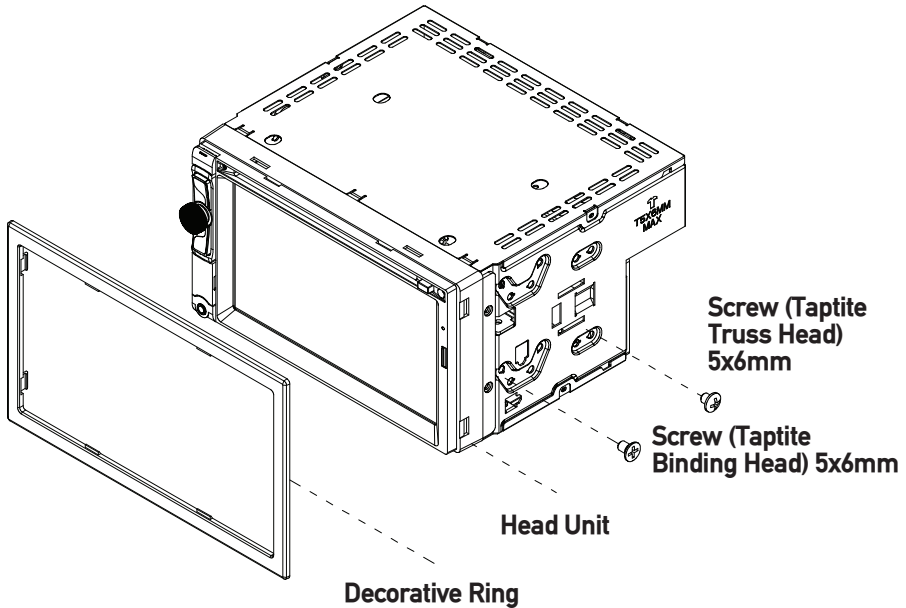

## TYPICAL FRONT-LOAD MOUNTING METHOD

# Wiring Diagram - Inputs/Outputs

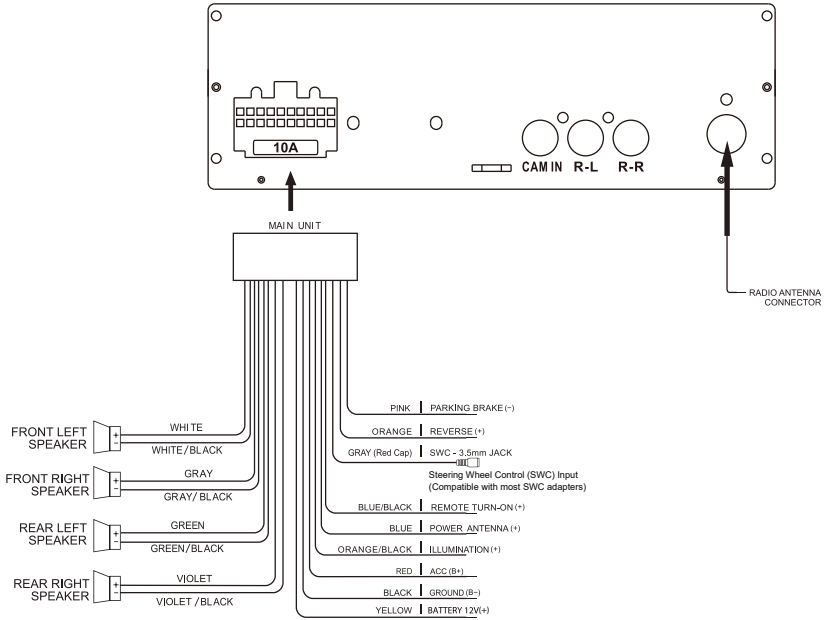

**Note:**

When replacing a fuse, make sure to use the correct type and amperage. Using an incorrect fuse could cause damage. The unit uses (1) 10 amp ATC mini style fuse located on the power connector.

**Wiring Notes:**

**Rear camera input**

A rear view camera (not included) can be used with the **Camera** input.



## XDVD251BT OPERATION

### Control Locations



- ① MicroSD Slot
- ② Microphone
- ③ Eject
- ④ Reset
- ⑤ Voice Control

- ⑥ Tune/Track Up
- ⑦ Power/Mute/Volume
- ⑧ Tune/Track Down
- ⑨ USB Port
- ⑩ Auxiliary Input

### Touch Screen Controls

The touch screen controls on the bottom of each screen allow direct access to important features during any mode of operation.

- 1. Standby Mode or Dimmer
- 2. Eject
- 3. Voice Control
- 4. Audio
- 5. Navigation Hot Button
- 6. Settings



## General Operation

<b>Power On/Off</b>	Momentarily press  to turn the unit on or off.
<b>Volume</b>	Rotate the volume knob to increase or decrease the volume level.
<b>Mute</b>	Momentarily press <b>MUTE</b> to silence the audio. Momentarily press <b>MUTE</b> again to return to the previously selected volume. Rotating the <b>volume knob</b> while the volume is muted will also cancel the mute function.
<b>Mode</b>	Press <b>MODE</b> to step through all available input modes: Radio, Disc, Settings, Rear Camera, USB, microSD, Bluetooth Phone, Bluetooth Audio and Auxiliary Input. Modes of operation are indicated on the display and/or the monitor. Optional USB device must be inserted to appear in the mode selection string.
<b>Auxiliary Input</b>	Connect external audio devices to the 3.5mm auxiliary input on the front panel.
<b>USB</b>	Insert a USB device to play MP3 files.
<b>Main Menu</b>	When the monitor is open, press the house icon in the top left corner to access the Main Menu screen.



## General Operation

### Setup Menu

From the Main Menu screen, press **SETTINGS** to access the Setup menu and adjust the following options.



#### General:

- OSD Language - Select English Only.
- Wallpaper - Select between three available wallpaper options.
- Screen Calibration - Select to calibrate the touch screen.
- Radio Area - Select your current geographic area: Europe, USA, South America, Russia and Asia.
- Time Setting - Adjust the current time (hours and minutes) and choose between a 12-hour and 24-hour clock.
- Beep - Select to turn the audible beep On or Off.
- Camera - Select to turn the rear camera On or Off.
- Version - Select to view information about the unit.
- Restore Default - Select to restore the unit to default settings.

#### Audio:

- Sound Effect - Select to access three sound effect sub-menus.
- EQ - Select from any preset equalization curve (Classic, Rock, Pop, Jazz, Beat, Flat) or use custom settings (User).
- Loudness - Turn the Loudness setting On or Off.

#### Video:

- Aspect Ratio - Select desired aspect ratio: 4:3PS, 4:3LB or 16:9.
- Adjust - Select to adjust levels of Brightness, Contrast, Hue, Saturation and Sharpness.
- Panel - Select to choose backlight settings: 10s, 20s, 30s or Off.

#### Bluetooth:

- Auto Connect - Turn auto connect feature On or Off.
- Auto Answer - Turn auto answer feature On or Off.



## AM/FM Tuner Operation



### Radio Operation

Select the Radio icon from the Main Menu screen.

### Main Menu ①

Press to return to Main Menu screen.

### Current Mode Indicator ②

Displays current mode of operation.

### Tune Frequency Down ③

Press << to tune radio to a lower frequency. Press < to tune the unit down one step at a time.

### Band ④

Press between 2 AM and 3 FM bands.

### Local / Distance ⑤

Press to toggle between Local and Distance tuning.

### Tune Frequency Up ⑥

Press >> to tune radio to a higher frequency. Press > to tune the unit up one step at a time.

### AS/PS ⑦

Press to scan presets and listen to the first 10 seconds of each. Press again to stop scanning and listen to the station. Press and hold to automatically find and store the strongest stations as presets.

### Stereo ⑧

Press to toggle between Stereo and Mono tuning.

### Preset Stations ⑨

Press and hold to set the current station in that preset spot. Press momentarily to recall the desired preset and begin playback.

## CD/USB/microSD Operation

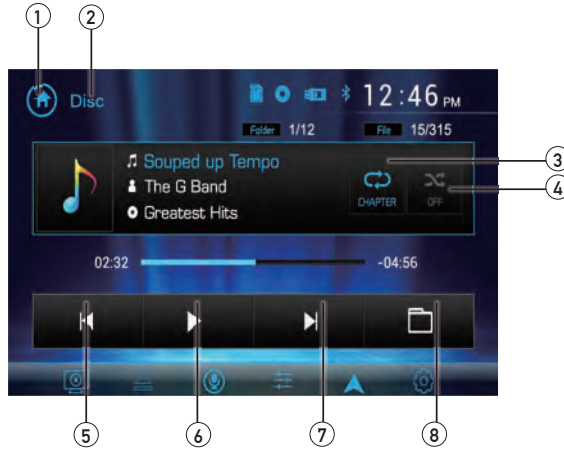

### CD/USB/microSD Operation

To play audio files from a disc or MP3 files from a disc or USB device, insert disc or device and playback will begin automatically. To return to disc or USB playback from another mode of operation, select the corresponding icon from the Main Menu.

- **Disc Playback** - Insert disc into the slot, and playback will begin automatically.
- **USB Playback** - Insert a USB device into the USB slot.
- **microSD Playback** - Insert a microSD card into the microSD slot.

**Main Menu** ① Press to return to Main Menu screen.

**Current Mode Indicator** ② Displays current mode of operation.

**Repeat** ③ Press to select a repeat option: Repeat 1, Repeat Folder or Repeat Off.

**Random** ④ Press to enable or disable random playback.

**Previous File / Track** ⑤ Press to go back to the previous file or track.

**Play / Pause** ⑥ Press to pause or resume playback.

**Next File / Track** ⑦ Press to advance to the next file or track.

**Folder Access** ⑧ Press to access all folders on device.

## Media Compatibility

<p><b>Media Compatibility</b></p>	<p>The following types of discs/files are compatible:</p> <ul style="list-style-type: none"> <li>• CD-DA, CD-ROM (ISO), CD-R, CD-RW</li> <li>• DVD Video, DVD+R/RW, DVD-R/RW</li> </ul> <p>The following types of discs/files are not compatible:</p> <ul style="list-style-type: none"> <li>• WMA files that are protected by DRM (Digital Rights Management)</li> <li>• WMA lossless format</li> <li>• Discs recorded with Track At Once or packet writing</li> <li>• MP3 PRO format, MP3 playlists</li> <li>• RMP format</li> <li>• WAV format</li> <li>• WMV format</li> <li>• AAC, protected AAC, M4A format, M4V format.</li> </ul> <p>Some recordable DVD's and CD's may be incompatible with this unit, depending on media type and recording method.</p>
<p><b>Playback Order</b></p>	<p>MP3 playback sequence begins in the root folder of the disc. USB device or microSD card. Any empty folders or folders that do not include MP3/JPG files are skipped.</p>
<p><b>Compatible Recording Formats</b></p>	<p>ISO9660 standards:</p> <ul style="list-style-type: none"> <li>• Maximum nested folder depth is 8 (including the root folder).</li> <li>• Valid characters for folder/file names are letters A-Z (all caps), numbers 0-9, and "_" (underscore). Some characters may not be displayed correctly, depending on the character type.</li> <li>• This device can play back discs in Joliet and other standards that conform to ISO9660. MP3 written in the formats other than the above may not play and/or their file names or folder names may not be displayed properly.</li> </ul>
<p><b>Notes</b></p>	<p>Some files may not play or be displayed correctly, depending on sampling rates and bit rates.</p> <p>For best results, use the following settings when ripping MP3 files:        128kbps or higher constant bit rate        44.1kHz or higher sampling frequency</p>

## DVD Operation



### Inserting a Disc

Insert disc into the slot, and playback will begin automatically. Sub-menus may have to be pressed to access the DVD content. Read the directions of your specific DVD disc for other features.

### Ejecting the Disc

Press  to eject the disc.

### Touchscreen Controls

Press anywhere on the LCD to display touch screen controls.

#### Main Menu ①

Press to return to Main Menu screen.

#### Elapsed Time ②

Displays elapsed time and time remaining on the DVD.

#### Repeat ③

Press to select from the following repeat options: Repeat Chapter, Repeat Title, Repeat All or Repeat Off

#### Previous Chapter ④

Press to return to the previous chapter on the DVD.

#### Play / Pause ⑤

Press to play or pause DVD playback.

#### Next Chapter ⑥

Press to advance to the next chapter.

#### Random ⑦

Press Random to play chapters in random order or Random Off to play disc in order.

#### Audio ⑧

Press to adjust audio language settings.

## DVD Operation



- Screen Setup** ⑨ Press to adjust screen color settings.
- Zoom** ⑩ Press to zoom in or out on an image.
- Subtitle** ⑪ Press to access subtitle options.
- Audio** ⑫ Press to adjust audio options.
- Monitor On/Off** ⑬ Press to put the monitor in standby mode.
- Settings** ⑭ Press to directly access the setup menu.

## Bluetooth Operation



### Preparation

Before you can use a Bluetooth device, it must be paired and connected. Make sure that Bluetooth is activated on your device before you begin the pairing process.

### Pairing a New Device

The unit broadcasts the pairing signal constantly when no devices are currently connected. Complete the pairing sequence from your Bluetooth device. Refer to the owner's manual for your device for more details. **The device name is "XDVD251BT" The Bluetooth passcode is "0000".** The unit can be in any mode of operation when pairing is performed. On certain phones, pairing may need to be done more than once.

### Connecting a Paired Device

Most Bluetooth devices support the auto-connect feature and will connect automatically if the device is in range when the unit is powered-on. If your device was previously paired but does not connect, enter the Bluetooth setup menu and ensure that Auto Connect is On.

### Bluetooth Phone

To access the phone, select Bluetooth Phone from the Main Menu or press the phone icon from any operational mode.

### Main Menu (1)

Press to return to the Main Menu screen.

### Current Mode Indicator (2)

Displays current mode of operation.

### Phone Keypad (3)

Use the phone keypad to dial the desired phone number. Alternately, numbers can be dialed directly from the phone.

### Bluetooth Phone (4)

Press to access Bluetooth phone.

### Bluetooth Music (5)

Press to access Bluetooth music.

### Available Devices (6)

Press to view a list of available devices.

### Talk (7)

Press to connect a call.

### End Call (8)

Press to end a call.

## Bluetooth Operation

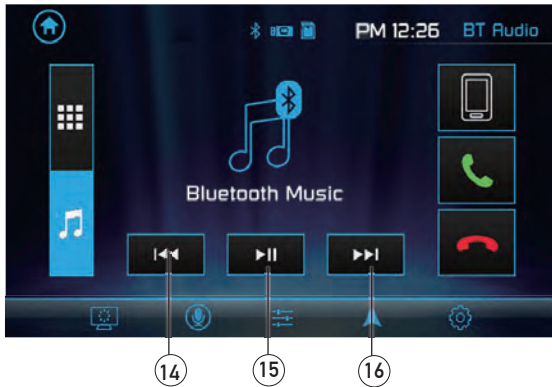

- Play / Pause** (15) Press to go back to the previous file or track.
- Next File/Track** (16) Press to pause or resume playback.
- Bluetooth Phone** (17) Press to advance to the next file or track.



## Navigation Hot Button

Press the Navi hot button to connect your receiver to your phone through the on-screen UI. Instantly stream audio from your favorite navigation apps on a connected smartphone through your car's receiver via Bluetooth.

**Note:** A smartphone with data is required to stream navigation.

## Dual iPlug P1 Smart App Remote Control

Use the Dual iPlug P1 Smart App Remote Control on an Apple or Android smartphone to control the receiver via Bluetooth.

Change the mode, station, song, volume, and settings directly from your smartphone without being in the receiver's line-of-sight.

Download the Dual iPlug P1 Smart App Remote Control from Apple App Store or Google Play Store and install it on your smartphone or tablet (QR code download link on the right).

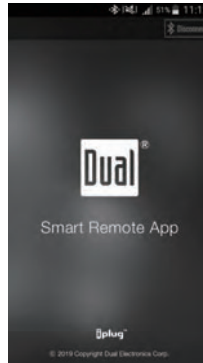

## Voice Activation

Your receiver is designed with an easy access voice activation button to use Siri® or the Google Assistant™ via your car's Bluetooth. Interact with your smartphone assistant while you drive with only the push of a button!

Bluetooth should be paired between your smartphone and the receiver. Press the voice activation button , and the receiver will switch into Bluetooth mode. This will activate Siri® or Google Assistant™ on your smartphone. You will need to manually switch back to the previous or desired mode once this operation is terminated.



---

## Front 3.5mm Aux Input

### Auxiliary Input

Connect an optional audio source into the 3.5mm (front panel) input.

Select auxiliary input from the Main Menu to listen to audio.

Adjust volume on the external audio source as needed (if connected to the headphone output of the device).

## Rear Camera Operation - (Optional)

### Using Rear Camera

Connect an optional rear camera to the Camera Input (Black RCA connector with violet cap). Refer to the wiring diagram for details.

Manual selection - Touch CAMERA icon from the Main Menu or from any operational mode (when enabled) to select camera mode. Touch the top left area on the screen to exit camera mode.

**Note:** The manual mode is for dedicated cameras that are ALWAYS on while driving, it is not meant for cameras that are connected to the vehicle's reverse light.

### Auto Selection

The unit will automatically select camera mode when connected to the reverse lamp circuitry.



## SWC Input Operation

The built-in SWC Interface is compatible with PAC steering wheel control modules. The PAC SWI-RC is recommended. A third-party adapter must be used in order for the XDVD251BT to be compatible with any steering wheel controls. The following controls are available for most vehicles.

1. Volume Up (+)	4. Preset (+)	7. Seek/Track Up (+)	10. BT Talk
2. Volume Down (-)	5. Preset (-)	8. Seek/Track Down (-)	11. BT End
3. Mute	6. Mode	9. Band	

**Note:** Not all OE steering wheel functions may be supported by the XDVD251BT

## PAC SWI-RC Installation Hints

1. Set "Radio Select Switch". Set the SWI-RC to position 7 - "Pioneer/Other/Sony".
2. To program, use the Pioneer/Sony/Other radio function mapping order for Dual units.
3. When programming the SWI-RC, if a function is not supported (or not desired), then the function **MUST** be skipped as per the PAC SWI-RC instructions.
4. The SWC function **MUST** be programmed in the correct order per the PAC SWI-RC radio function mapping order instructions.

Function Order	Function Mapping	SWI-RC (3.3VDC Reference)	
		Center Pin (Ring) Voltage (Function Select)	Tip Pin Voltage
1	Volume +	H 5.0v	2.07
2	Volume -	H 5.0v	2.32
3	Mute	H 5.0v	1.01
4	Preset +	L 0.0V	1.54
5	Preset -	L 0.0V	1.81
6	Source	H 5.0v	0.60
7	Seek + / Track +	H 5.0v	1.54
8	Seek - / Track -	H 5.0v	1.81
9	Band	H 5.0v	2.73
10	BT Talk	L 0.0V	0.60
11	BT End	L 0.0V	1.01

## Troubleshooting

General		
Problem	Cause	Action
Unit will not turn on (no power)	Yellow wire not connected or incorrect voltage	Check connections for proper voltage (11~16VDC)
	Red wire not connected or incorrect voltage	
	Black wire not connected	Check connection to ground
Unit has power (but no sound)	Fuse blown	Replace fuse(s)
	Speaker wires not connected	Check connections at speakers
	One or more speaker wires touching each other or touching chassis ground	Insulate all bare speaker wires from each other and chassis ground
Unit blows fuse(s)	Yellow or red wire touching chassis ground	Check for pinched wire
	Speaker wires touching chassis ground	Check for pinched wire
	Incorrect fuse rating	Use fuses with correct rating
Unit has audio (but no video)	Parking brake safety circuit not connected Parking brake not applied	Check connections at parking brake Apply parking brake as described on page 26
No video display (when in reverse)	Reverse circuit not connected Vehicle is not in reverse	Check connections at reverse lamp Select reverse gear
DVD does not start playback	Physical defect in media Wrong region	Check media for scratches Use discs labeled "Region 1" or "All" only
Excessive skipping	Unit is not mounted correctly	Check mounting sleeve
	Physical defect in media	Check media for scratches
Disc Region Incorrect appears on display	Region code error	Use discs labeled "Region 1" or "All" only

### For Your Records

Please keep your original sales receipt and be prepared to provide this receipt in the event you require service, as your original receipt is considered the best proof of purchase and indicates the date you purchased your Dual product.

Dealer Name \_\_\_\_\_

Dealer Phone \_\_\_\_\_

Purchase Date \_\_\_\_\_

### Register Your Product

Register your product online at [www.dualav.com](http://www.dualav.com).



## XDVD251BT OPERATION

# Specifications

<b>Disc</b>	Frequency response: <b>20Hz-20kHz</b> Channel separation @ 1kHz: <b>&gt;80dB</b> D/A converter: <b>24 Bit</b>
<b>FM Tuner</b>	Tuning range: <b>87.5MHz-107.9MHz</b> Usable sensitivity: <b>10dBf</b> 50dB quieting sensitivity: <b>20dBf</b> Stereo separation @ 1kHz: <b>38dB</b> Frequency response: <b>30Hz-13kHz</b>
<b>AM Tuner</b>	Tuning range: <b>530kHz-1710kHz</b> Usable sensitivity: <b>24uV</b> Frequency response: <b>30Hz-2.3kHz</b>
<b>Front USB</b>	Compatibility: <b>High Speed USB 2.0</b> USB Class: <b>Mass storage class</b>
<b>Monitor</b>	Panel size: <b>6.2" diagonal measurement</b> View angle (up/down/left/right): <b>50/70/70/70</b> Resolution: <b>800 (H) x 480 (V)</b> Brightness (cd/m <sup>2</sup> ): <b>250</b> Contrast ratio: <b>500:1</b> Pixels: <b>1,152,000</b>
<b>General</b>	Speaker output impedance: <b>4 ohms</b> Line output voltage: <b>1.2 volt RMS</b> Line output impedance: <b>200 ohms</b> Chassis dimensions: <b>7" x 7" x 4" (W x D x H)</b>  Design and specifications subject to change without notice.



CEA-2006 Power Standard Specifications  
(reference: 14.4VDC +/- 0.2V, 20Hz~20kHz)

Power Output: 16 Watts RMS x 4 channels at 4 ohms and  $\leq 1\%$  THD+N  
Signal to Noise Ratio: 80dB (reference: 1 watt into 4 ohms)

---

## Limited One Year Warranty

This warranty gives you specific legal rights. You may also have other rights which vary from state to state.

Dual Electronics Corp. warrants this product to the original purchaser to be free from defects in material and workmanship for a period of one year from the date of the original purchase.

Dual Electronics Corp. agrees, at our option, during the warranty period, to repair any defect in material or workmanship or to furnish an equal new, renewed or comparable product (whichever is deemed necessary) in exchange without charges, subject to verification of the defect or malfunction and proof of the date of purchase. Subsequent replacement products are warranted for the balance of the original warranty period.

**Who is covered?** This warranty is extended to the original retail purchaser for products purchased from an authorized Dual dealer and used in the U.S.A.

**What is covered?** This warranty covers all defects in material and workmanship in this product. The following are not covered: software, installation/removal costs, damage resulting from accident, misuse, abuse, neglect, product modification, improper installation, incorrect line voltage, unauthorized repair or failure to follow instructions supplied with the product, or damage occurring during return shipment of the product. Specific license conditions and copyright notices for the software can be found via [www.dualav.com](http://www.dualav.com).

### What to do?

1. Before you call for service, check the troubleshooting guide in your owner's manual. A slight adjustment of any custom controls may save you a service call.
2. If you require service during the warranty period, you must carefully pack the product (preferably in the original package) and ship it by prepaid transportation with a copy of the original receipt from the retailer to an authorized service center.
3. Please describe your problem in writing and include your name, a return UPS shipping address (P.O. Box not acceptable), and a daytime phone number with your shipment.
4. For more information and for the location of the nearest authorized service center please contact us by one of the following methods:
  - Call us toll-free at 1-866-382-5476
  - E-mail us at [cs@dualav.com](mailto:cs@dualav.com)

**Exclusion of Certain Damages:** This warranty is exclusive and in lieu of any and all other warranties, expressed or implied, including without limitation the implied warranties of merchantability and fitness for a particular purpose and any obligation, liability, right, claim or remedy in contract or tort, whether or not arising from the company's negligence, actual or imputed. No person or representative is authorized to assume for the company any other liability in connection with the sale of this product. In no event shall the company be liable for indirect, incidental or consequential damages.



This product incorporates copyright protection technology that is protected by method claims of certain U.S. patents and other intellectual property rights owned by Macrovision Corporation and other rights owners. Use of this copyright protection technology must be authorized by Macrovision Corporation, and is intended for home and other limited viewing uses only unless otherwise authorized by Macrovision Corporation. Reverse engineering or disassembly is prohibited.

The Bluetooth® word mark and logos are owned by the Bluetooth SIG, Inc.

Other trademarks and trade names are those of their respective owners.

Dual Electronics Corp.  
Toll Free: 1-866-382-5476  
Monday-Friday, 9AM-5PM EST

[www.dualav.com](http://www.dualav.com)  
©2020 Dual Electronics Corp. All rights reserved.  
NSA1119-V01  
Printed in China