



DVD



MECHLESS

XDVD256BT

INSTALLATION/OWNER'S MANUAL

DVD Multimedia Receiver with Bluetooth®
featuring a 6.2" Touch Screen Display



Safety Notes: (Only DVD Receiver)

The DVD video display of the in-dash unit will not operate while the vehicle is moving. This is a safety feature to prevent driver distraction. In-dash DVD video functions will only operate when vehicle is in Park and the parking brake is engaged. It is illegal in most states for the driver to view video while the vehicle is in motion.

Copyright Notes

This product incorporates copyright protection technology that is protected by method claims of certain U.S. patents and other intellectual property rights owned by Macrovision Corporation and other rights owners. Use of this copyright protection technology must be authorized by Macrovision Corporation, and is intended for home and other limited viewing uses only unless otherwise authorized by Macrovision Corporation. Reverse engineering or disassembly is prohibited.

The Bluetooth® word mark and logos are owned by the Bluetooth SIG, Inc.

SD Logo is a trademark of SD-3C, LLC.

Other trademarks and trade names are those of their respective owners.



Table of Contents

	Page
Warning Statement	3
Safety Information/Precautions	4
Preparation/Mounting	5
Wiring Diagram	6
Control Locations	7
Remote Preparation	8
General Operation	9-11
AM/FM Tuner Operation	12-13
CD/USB/SD Card Operation	14-18
DVD Operation	19-20
Bluetooth Operation	21-22
Auxiliary Inputs/Rear Camera Operation.....	23
Warranty	24
Specifications	25
Troubleshooting	26



XDVD256BT PREPARATION

⚠ WARNING ⚠

Upon installation of this Monitor/DVD player ("unit") into a vehicle, the driver of the vehicle must not operate this unit by watching videos or playing video games while driving. Failure to follow this instruction could lead to driver distraction which could result in serious injury or death to the vehicle's occupants or persons outside the vehicle and/or property damage.

Several states prohibit the installation of monitors/DVD players if the screen is visible from the driver's seat. If you reside in a jurisdiction which has enacted such a law, this unit must not be installed so that the screen is visible from the driver's seat. When installing this unit in the front console/dashboard, the unit must be positioned so that it is facing the front passenger seat only. Failure to follow this instruction could lead to driver distraction which could result in serious injury or death to the vehicle's occupants or persons outside the vehicle and/or property damage.

This unit is designed so that it may be operated only when the vehicle is in "Park" and the parking brake is fully engaged. To this end, this unit includes a parking brake lock-out feature which prohibits the unit from operating if the vehicle is not in "Park" and/or the parking brake is not fully engaged. When installing this unit, the installer must connect the parking brake detect wire to the parking brake mechanism in order to make the parking brake lock-out feature operable. **DO NOT** simply ground the parking brake detect wire to a metal portion of the vehicle. Failure to properly install the parking brake lock-out feature could lead to driver distraction which could result in serious injury or death to the driver's occupants or persons outside the vehicle and/or property damage.

Once the parking brake lock-out feature is installed, the owner/user must not attempt to disrupt/neutralize the parking brake lock-out feature by (a) partially engaging the parking brake and/or (b) purchasing/using any device or unit designed to send necessary brake signals to the unit. Failure to follow these instructions could lead to driver distraction which could result in serious injury or death to the driver's occupants or persons outside the vehicle and/or property damage.

When operating this unit, keep the unit's volume level low enough so that the vehicle's occupants can hear traffic-related sounds such as police and emergency vehicles. Failure to follow this instruction could lead to driver distraction which could result in serious injury or death to the vehicle's occupants or persons outside the vehicle and/or property damage.

*** Note**

The above video Content is for DVD Receiver Only.

Safety Information

Please read all instructions carefully before attempting to install or operate.

Due to its technical nature, it is highly recommended that your DUAL XDVD256BT is installed by a professional installer or an authorized dealer. This product is only for use in vehicles with 12VDC negative ground only.

To prevent damage or injury:

- Make sure to ground the unit securely to the vehicle chassis ground.
- Do not remove the top or bottom covers of the unit.
- Do not install the unit in a spot exposed to direct sunlight or excessive heat or the possibility of water splashing.
- Do not subject the unit to excessive shock.
- When replacing a fuse, only use a new one with the prescribed rating. Using a fuse with the wrong rating may cause the unit to malfunction.
- To prevent short circuits when replacing a fuse, disconnect the wiring harness first.
- Use only the provided hardware and wire harness.
- You cannot view video while the vehicle is moving. Find a safe place to park and engage the parking brake.
- If you experience problems during installation, consult your nearest DUAL dealer.
- If the unit malfunctions, reset the unit as described on page 10 first. If the problem still persists, consult your nearest DUAL dealer or call tech assistance @ 1-866-382-5476.
- To clean the monitor, wipe only with a dry silicone cloth or soft cloth. Do not use a stiff cloth, or volatile solvents such as paint thinner and alcohol. They can scratch the surface of the panel and/or remove the printing.
- When the temperature of the unit falls (as in winter), the liquid crystal inside the screen will become darker than usual. Normal brightness will return after using the monitor for a while.
- When extending the ignition, battery or ground cables, make sure to use automotive-grade cables or other cables with an area of 0.75mm (AWG 18) or more to prevent voltage drops.
- Do not touch the liquid crystal fluid if the LCD is damaged or broken. The liquid crystal fluid may be hazardous to your health or fatal. If the liquid crystal fluid from the LCD contacts your body or clothing, wash it off with soap immediately.

FCC Compliance

This device complies with Part 15 of the FCC Rules. Operation is subject to the following two conditions:

- (1) this device may not cause harmful interference, and
- (2) this device must accept any interference received, including interference that may cause undesired operation.

Warning: Changes or modifications to this unit not expressly approved by the party responsible for compliance could void the user's authority to operate the equipment.

Note: This equipment has been tested and found to comply with the limits for a Class B digital device, pursuant to Part 15 of the FCC Rules. These limits are designed to provide reasonable protection against harmful interference in a residential installation. This equipment generates, uses and can radiate radio frequency energy and, if not installed and used in accordance with the instructions, may cause harmful interference to radio communications. However, there is no guarantee that interference will not occur in a particular installation. If this equipment does cause harmful interference to radio or television reception, which can be determined by turning the equipment off and on, the user is encouraged to try to correct the interference by one or more of the following measures:

- Reorient or relocate the receiving antenna.
- Increase the separation between the equipment and receiver.
- Connect the equipment into an outlet on a circuit different from that to which the receiver is connected.
- Consult the dealer or an experienced radio/TV technician for help.



XDVD256BT INSTALLATION

Preparation

Before You Start

- Disconnect negative battery terminal. Consult a qualified technician for instructions.
- Avoid installing the unit where it would be subject to high temperatures, such as from direct sunlight, or where it would be subject to dust, dirt or excessive vibration.

Getting Started

- Insert the supplied keys into the slots as shown.
- Connect wiring harness as shown on page 6. Consult a qualified technician if you are unsure.
- Certain vehicles may require an installation kit and/or wiring harness adapter (sold separately).
- Reconnect negative battery terminal, and test for correct operation.
- Snap trim ring into place (if required).

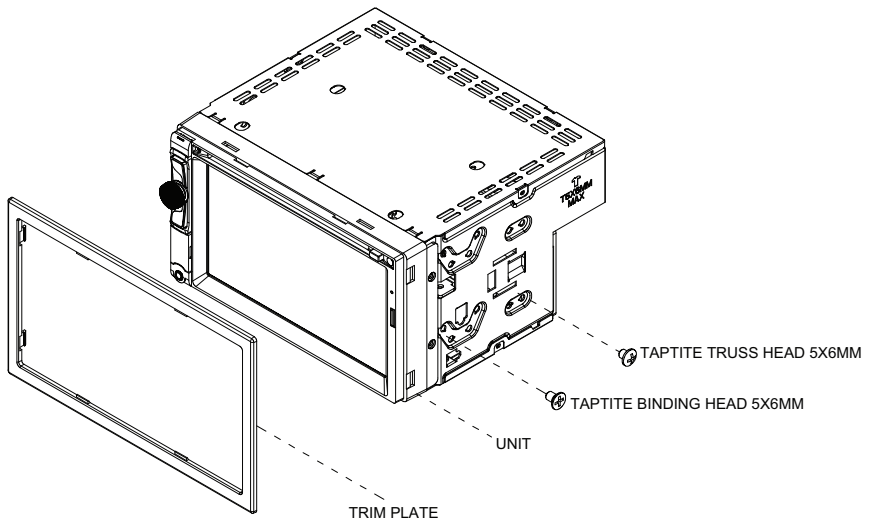
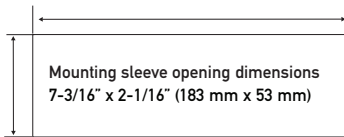

TYPICAL FRONT-LOAD DIN MOUNTING METHOD

Wiring Diagram - Inputs/Outputs

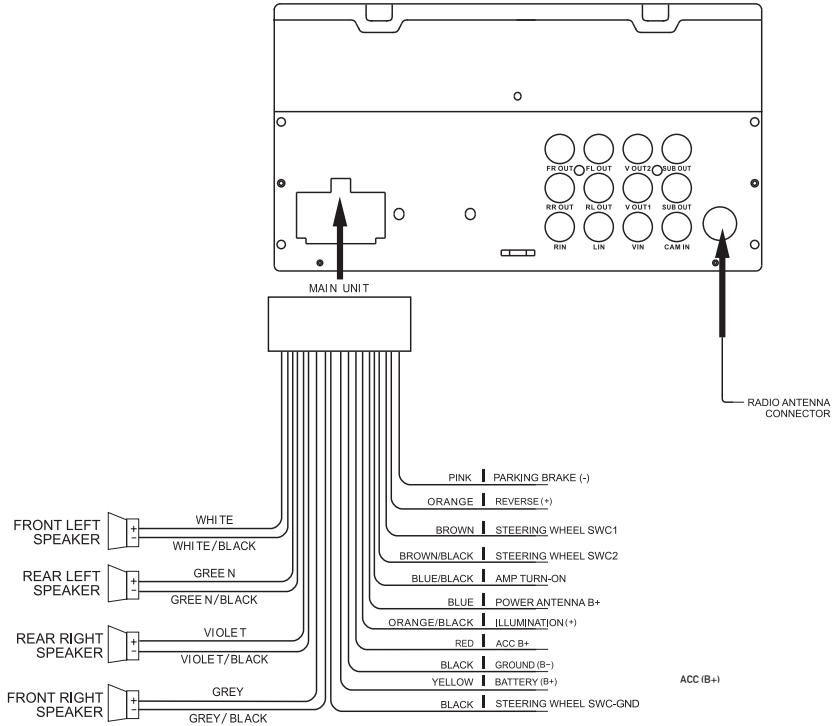

Note:

When replacing a fuse, make sure to use the correct type and amperage. Using an incorrect fuse could cause damage. The unit uses (1) 15 amp ATM mini style fuse located inside the in-line filter box.

Wiring Notes:

Subwoofer output

The Subwoofer preamp audio output (black jacket with green RCA) is active in all audio modes.

Rear camera input

A rear view camera (not included) can be used with the Camera input.



XDVD256BT OPERATION

Control Locations



- ① Mode
- ② Tune / Track Up
- ③ Volume / Power / Mute
- ④ Tune / Track Down
- ⑤ USB Port

- ⑥ Auxiliary Input
- ⑦ Eject
- ⑧ Microphone
- ⑨ SD Card Slot

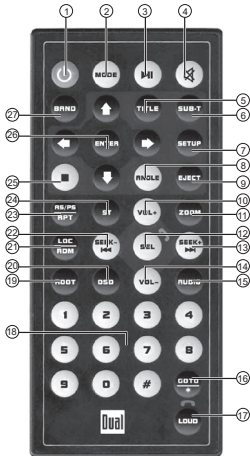

- 1 Power
- 2 Mode
- 3 Play / Pause
- 4 Mute
- 5 Title
- 6 Subtitle
- 7 Setup
- 8 Angle
- 9 Eject
- 10 Volume Up
- 11 Zoom
- 12 Select / Talk
- 13 Seek Up / Next Track
- 14 Volume Down
- 15 Audio

- 16 Goto/*
- 17 Loud / End call
- 18 Number Keys
- 19 Root
- 20 On Screen Display
- 21 Local / Random
- 22 Seek Down / Previous Track
- 23 AS/PS / Repeat
- 24 Stereo
- 25 Stop
- 26 Enter
- 27 Band

Remote Control Preparation

Remove battery insulation tape .

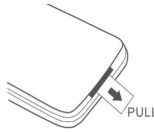

To insert or replace the battery, remove the battery holder.

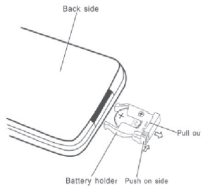

Remove the battery from the battery holder.

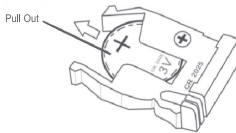

Install the new battery.
Make sure to keep the (+) side up.

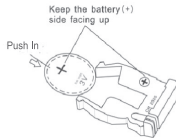

Insert the battery holder .

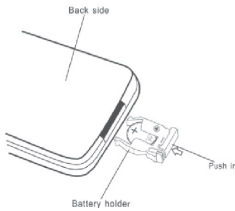



Notes:

- The remote control uses one 3 volt Lithium CR2025 battery. Remove the battery if the remote will not be used for a month or longer.
- Remove and dispose of battery properly.
- Do not store battery with metallic objects or materials.



General Operation

Power On/Off	Momentarily press  to turn the unit on. Press and hold  to turn the unit off.
Volume	Rotate the volume knob to increase or decrease the volume level.
Mute	Momentarily press the volume knob to silence the audio. Momentarily press  again to return to the previously selected volume. Rotating the volume knob while the volume is muted will also cancel the mute function.
Mode	Press MODE to step through all available input modes: Radio, Disc (which includes DVD and CD playback), USB, SD, Bluetooth Phone, Bluetooth Music, Rear Camera, Auxiliary Input, AV Input and Setup. Modes of operation are indicated on the display and/or the monitor. Optional USB device and SD card must be connected/inserted to appear in the mode selection string.
Auxiliary Input	Connect external audio/video devices to the 3.5mm auxiliary input on the front panel.
USB Port	Connect a USB device to play MP3 files.
SD Card	Insert an SD card into the SD slot (located behind the faceplate) to play MP3 files.
Main Menu	When the monitor is open, press the house icon in the top left corner to access the Main Menu screen.



1. Put the monitor into standby mode.
2. Eject the disc.

General Operation

Setup Menu

From the Main Menu screen, press **SETUP** in the bottom right corner to access the Setup menu and select from six categories across the bottom: General, Time, Video, Language, Calibration and SWC.



General:

- **Key Beep** - Select a **OFF** or **ON** to select whether or not the unit beeps each time a key is pressed.
- **Disc** - Adjust the following disc options:
 - **TV Type** - Select 4:3PS, 4:3 LB or 16:9.
- **Radio** - Adjust the following radio options:
 - Select between the following region settings: **EUROPE**, **SOUTH AMERICA**, **ASIA** and **RUSSIA**.
- **Bluetooth** - Adjust the following Bluetooth options:
 - Turn Bluetooth **On** or **OFF**.
 - Turn Auto Answer feature **On** or **OFF** to determine whether or not the unit will automatically answer incoming calls.
 - Turn Auto Connect feature **On** or **OFF** to determine whether or not the unit will automatically connect to available devices.
- **Wallpaper** - Select from three different wallpaper options.
- **About** - Select to view information about the unit.



General Operation

Setup Menu

Time:

- **Hour** - Press < or > to adjust the hour down or up.
- **Minute** - Press < or > to adjust the minutes down or up.
- **Format** - Select between a 12HR or 24HR clock display.

Video:

- **Brightness** - Drag to adjust between 0 and 12.
- **Contrast** - Drag to adjust between 0 and 12.
- **Hue** - Drag to adjust between 0 and 12.
- **Saturation** - Drag to adjust between 0 and 12.
- **Sharpness** - Drag to adjust between 0 and 12.

Language:

- **English** - Set the unit language to English.

Steering Wheel Controls (SWC):

- See insert for SWS programming information.

Reset

To resolve abnormal operation or if the unit is inoperable, use the tip of a pen to press the **RESET** button (located behind the faceplate). The unit will reset the main processor to the default settings.

Audio

From any mode of operation, press Audio to adjust the following Audio options:

- **EQ** - Select from the preset EQ options: CLASSIC, ROCK, POP, JAZZ, BEAT OR FLAT, or select USER to manually adjust 60Hz, 150Hz, 400Hz, 1kHz, 3kHz, 7kHz, 15kHz between -7 and 7.
- **Fader/Balance** - Drag to adjust Fader options between 8F (front) and 8R (rear) and Balance options between 8L (left) and 8R (right).
- **Subwoofer/Loudness**
 - Adjust subwoofer volume from 1-6, or turn subwoofer **OFF**.
 - Select between **OFF**, **LOW** or **HIGH** loudness levels.
 - Center frequency: FLAT, 80Hz, 120Hz, 160Hz.
- **Loudness**
 - Select between OFF/ON.
 - Loud Cutoff Frequency: 400 Hz, 800Hz, 2400 Hz.

AM/FM Tuner Operation



Radio Operation

Select the Radio icon from the Main Menu screen.

Main Menu (1)

Press to return to Main Menu screen.

Current Mode Indicator (2)

Displays current mode of operation.

Tune Frequency Down (3)

Press << to tune radio to a lower frequency. Press < to tune the unit down one step at a time.

Tune Frequency Up (4)

Press >> to tune radio to a higher frequency. Press > to tune the unit up one step at a time.

Preset (5)

Press to display the six preset stations stored in memory in the current band. To store a preset station, tune unit to desired station, then press and hold the desired preset button to store the current station in that preset spot. Momentarily press any preset station to play it instantly.

Band (6)

Press between 2 AM and 3 FM bands.

Local / Distance (7)

Press to toggle between Local (LOC) and Distance (DX) tuning.

Stereo (8)

Press to toggle between Stereo (ST) and Mono operation.

AS/PS (9)

Press to scan presets and listen to the first 10 seconds of each. Press again to stop scanning and listen to the station. Press and hold to automatically find and store the strongest stations as presets.

AM/FM Tuner Operation



- Monitor On/Off** ⑩ Press to put the monitor into standby mode.
- Eject** ⑪ Press to eject the disc.
- Audio** ⑫ Press to access the Audio menu.
- Setting** ⑬ Press to access the Setup menu.

CD/USB/SD Card Operation

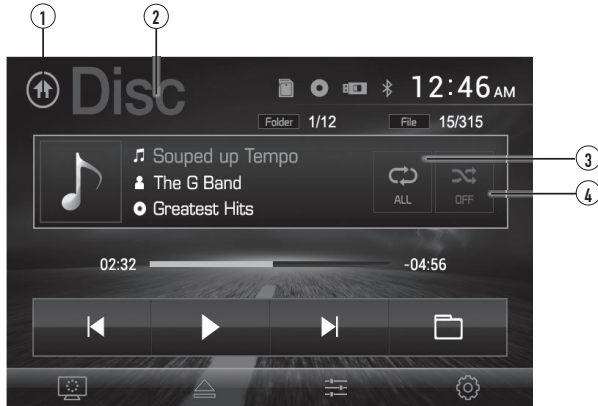

CD/USB or SD Operation

To play audio files from a disc or MP3 files from a disc, USB device or SD card, insert disc or device and playback will begin automatically. To return to disc, USB or SD card playback from another mode of operation, select the corresponding icon from the Main Menu.

- **Disc Playback** - Insert disc into the slot, and playback will begin automatically.
- **USB Playback** - Insert a USB device into the USB slot on the side of the unit.
- **SD Card Playback** - Insert SD card into the SD slot on the top of the unit. When inserting an SD card, the label should face up.

Main Menu ① Press to return to Main Menu screen.

Current Mode Indicator ② Displays current mode of operation.

Repeat ③ Press to select a repeat option: Repeat 1, Repeat Folder or Repeat Off.

Random ④ Press to enable or disable random playback.

CD/USB/SD Card Operation

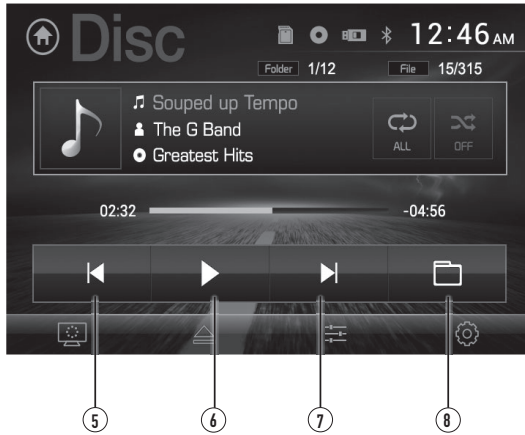

Previous File/Track ⑤

Press to go back to the previous file or track.

Play / Pause ⑥

Press to pause or resume playback.

Next File/Track ⑦

Press to advance to the next file or track.

Direct File Access ⑧

Press to access the directory of folders and files. Use the up/down arrows to scroll through the folder list, then press on the name of the desired folder to access it. Use the up/down arrows to scroll through the file list, then press on the name of the desired file to access it.

The default display will show Music files. Select the Photo or Video icons at the bottom of the screen to display those files instead.

Media Compatibility

Media Compatibility	<p>The following types of discs/files are compatible:</p> <ul style="list-style-type: none"> • CD-DA, CD-ROM (ISO), CD-R, CD-RW • DVD Video, DVD+R/RW, DVD-R/RW • AVI - Max video resolution: 720x480, Max video bit rate: 5000 kbps <p>The following types of discs/files are not compatible:</p> <ul style="list-style-type: none"> • WMA files that are protected by DRM (Digital Rights Management) • WMA lossless format • Discs recorded with Track At Once or packet writing • MP3 PRO format, MP3 playlists • RMP format • WAV format • WMV format • AAC, protected AAC, M4A format, M4V. <p>Some recordable DVD's and CD's may be incompatible with this unit, depending on media type and recording method.</p>
Playback Order	<p>MP3 playback sequence begins in the root folder of the disc, USB flash drive or SD card. Any empty folders or folders that do not include MP3/JPG files are skipped.</p>
Compatible Recording Formats	<p>ISO9660 standards:</p> <ul style="list-style-type: none"> • Maximum nested folder depth is 8 (including the root folder). • Valid characters for folder/file names are letters A-Z (all caps), numbers 0-9, and "_" (underscore). Some characters may not be displayed correctly, depending on the character type. • This device can play back discs in Joliet and other standards that conform to ISO9660. MP3 written in the formats other than the above may not play and/or their file names or folder names may not be displayed properly.
Notes	<p>Some files may not play or be displayed correctly, depending on sampling rates and bit rates.</p> <p>For best results, use the following settings when ripping MP3 files: 128kbps or higher constant bit rate 44.1kHz or higher sampling frequency</p>

DVD Operation

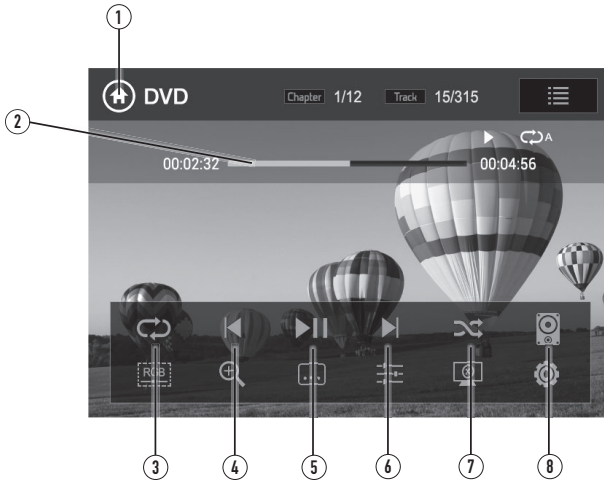

Inserting a Disc

Insert disc into the slot, and playback will begin automatically. Sub-menus may have to be pressed to access the DVD content. Read the directions of your specific DVD disc for other features.

Ejecting the Disc

Press  to eject the disc.

Touchscreen Controls

Press anywhere on the LCD to display touch screen controls.

Main Menu

Press to return to Main Menu screen.

Elapsed Time

Displays elapsed time and time remaining on the DVD.

Repeat

Press to select from the following repeat options: Repeat Chapter, Repeat Title, Repeat All or Repeat Off.

Previous Chapter

Press to return to the previous chapter on the DVD.

Play / Pause

Press to play or pause DVD playback.

Next Chapter

Press to advance to the next chapter.

Random

Press Random to play chapters in random order or Random Off to play disc in order.

Language Setting

Press to adjust audio language settings.

DVD Operation



- Screen Setup** ⑨ Press to adjust screen color settings.
- Zoom** ⑩ Press to zoom in and out on an image.
- Subtitle** ⑪ Press to access subtitle options.
- Audio** ⑫ Press to adjust Audio options.
- Monitor On/Off** ⑬ Press to put the monitor in standby mode.
- Setup** ⑭ Press to access the Setup menu.

Bluetooth Operation



Preparation

Before you can use a Bluetooth device, it must be paired and connected. Make sure that Bluetooth is activated on your device before you begin the pairing process.

Pairing a New Device

The unit broadcasts the pairing signal constantly when no devices are currently connected. Complete the pairing sequence from your Bluetooth device. Refer to the owner's manual for your device for more details. **The device name is "Dual Multimedia Receiver". The Bluetooth passcode "0000".** The unit can be in any mode of operation when pairing is performed.

Note: On certain phones, pairing may need to be done more than once if there are connectivity issues.

Connecting a Paired Device

Most Bluetooth devices support the auto-connect feature and will connect automatically if the device is in range when the unit is powered-on. If your device was previously paired but does not connect, enter the Bluetooth setup menu and ensure that Auto Connect is On.

Bluetooth Phone

To access the phone, select Bluetooth Phone from the Main Menu or press the phone icon from any operational mode.

Main Menu ①

Press to return to the Main Menu screen.

Current Mode Indicator ②

Displays current mode of operation.

Phone Keypad ③

Use the phone keypad to dial the desired phone number. Alternately, numbers can be dialed directly from the phone.

Phone Transfer ④

Press to transfer audio between the head unit and mobile phone.

Talk ⑤

Press to connect a call.

End Call ⑥

Press to end a call.

BT Music ⑦

Press to access Music Streaming mode.

Redial ⑧

Press to redial the last number called.

Bluetooth Operation



9

10

11

12



13

14

15

Monitor On/Off ⑨ Press to put the monitor in standby mode.

Eject ⑩ Press to eject the disc.

Audio ⑪ Press to adjust Audio options.

Setup ⑫ Press to access the Setup menu.

Bluetooth Music Select this option from the Main Menu to access Bluetooth Music features.

Previous File / Track ⑬ Press to go back to the previous file or track.

Play / Pause ⑭ Press to pause or resume playback.

Next File/Track ⑮ Press to advance to the next file or track.



Front 3.5mm Aux Input & Rear RCA A/V Input

Auxiliary Input	<p>Connect an optional audio source into the 3.5mm (front panel) input.</p> <p>Select auxiliary input from the Main Menu to listen to audio.</p> <p>Adjust volume on the external audio source as needed (if connected to the headphone output of the device).</p>
Using AV Input	<p>Connect an optional audio/video source to the rear auxiliary input (Red/White/Yellow RCA connectors). Refer to page 6 for details.</p> <p>Select AV Input from the Main Menu to listen to audio.</p> <p>Engage parking brake to watch video.</p>

Rear Camera Operation - (Optional)

Using Rear Camera	<p>Connect an optional rear camera to the Camera Input (Black RCA connector). Refer to the wiring diagram for details.</p> <p>Manual selection - Touch CAMERA icon from the Main Menu or from any operational mode (when enabled) to select camera mode. Touch the top left area on the screen to exit camera mode.</p> <p>Note: The manual mode is for dedicated cameras that are ALWAYS on while driving, it is not meant for cameras that are connected to the vehicle's reverse light.</p>
Auto Selection	<p>The unit will automatically select camera mode when connected to the reverse lamp circuitry.</p> <p>Note: The external video output is not active when using the rear camera input.</p>



Limited One Year Warranty

This warranty gives you specific legal rights. You may also have other rights which vary from state to state.

Dual Electronics Corp. warrants this product to the original purchaser to be free from defects in material and workmanship for a period of one year from the date of the original purchase.

Dual Electronics Corp. agrees, at our option, during the warranty period, to repair any defect in material or workmanship or to furnish an equal new, renewed or comparable product (whichever is deemed necessary) in exchange without charges, subject to verification of the defect or malfunction and proof of the date of purchase. Subsequent replacement products are warranted for the balance of the original warranty period.

Who is covered? This warranty is extended to the original retail purchaser for products purchased from an authorized Dual dealer and used in the U.S.A.

What is covered? This warranty covers all defects in material and workmanship in this product. The following are not covered: software, installation/removal costs, damage resulting from accident, misuse, abuse, neglect, product modification, improper installation, incorrect line voltage, unauthorized repair or failure to follow instructions supplied with the product, or damage occurring during return shipment of the product. Specific license conditions and copyright notices for the software can be found via www.dualav.com.

What to do?

1. Before you call for service, check the troubleshooting guide in your owner's manual. A slight adjustment of any custom controls may save you a service call.
2. If you require service during the warranty period, you must carefully pack the product (preferably in the original package) and ship it by prepaid transportation with a copy of the original receipt from the retailer to an authorized service center.
3. Please describe your problem in writing and include your name, a return UPS shipping address (P.O. Box not acceptable), and a daytime phone number with your shipment.
4. For more information and for the location of the nearest authorized service center please contact us by one of the following methods:
 - Call us toll-free at 1-866-382-5476
 - E-mail us at cs@dualav.com

Exclusion of Certain Damages: This warranty is exclusive and in lieu of any and all other warranties, expressed or implied, including without limitation the implied warranties of merchantability and fitness for a particular purpose and any obligation, liability, right, claim or remedy in contract or tort, whether or not arising from the company's negligence, actual or imputed. No person or representative is authorized to assume for the company any other liability in connection with the sale of this product. In no event shall the company be liable for indirect, incidental or consequential damages.



XDVD256BT OPERATION

Specifications

Disc	Frequency response: 20Hz-20kHz Channel separation @ 1kHz: >80dB D/A converter: 24 Bit
FM Tuner	Tuning range: 87.5MHz-107.9MHz Usable sensitivity: 10dBf 50dB quieting sensitivity: 20dBf Stereo separation @ 1kHz: 38dB Frequency response: 30Hz-13kHz
AM Tuner	Tuning range: 530kHz-1710kHz Usable sensitivity: 24uV Frequency response: 30Hz-2.3kHz
Front USB	Compatibility: High Speed USB 2.0 USB Class: Mass storage class
SD	Compatibility: Micro SD memory card & Micro SDHC memory card
Monitor	Panel size: 6.2" diagonal measurement View angle (up/down/left/right): 50/70/70/70 Resolution: 800 (H) x 480 (V) Brightness (cd/m ²): 250 Contrast ratio: 500:1 Pixels: 1,152,000
General	Speaker output impedance: 4 ohms Line output voltage: 4 volt RMS Line output impedance: 200 ohms Chassis dimensions: 7" x 7" x 4" (W x D x H) Design and specifications subject to change without notice.



CEA-2006 Power Standard Specifications
(reference: 14.4VDC +/- 0.2V, 20Hz~20kHz)

Power Output: 16 Watts RMS x 4 channels at 4 ohms and $\leq 1\%$ THD+N
Signal to Noise Ratio: 80dBA (reference: 1 watt into 4 ohms)



Troubleshooting

General		
Problem	Cause	Action
Unit will not turn on (no power)	Yellow wire not connected or incorrect voltage Red wire not connected or incorrect voltage	Check connections for proper voltage (11-16VDC)
	Black wire not connected	Check connection to ground
	Fuse blown	Replace fuse(s)
Unit has power (but no sound)	Speaker wires not connected	Check connections at speakers
	One or more speaker wires touching each other or touching chassis ground	Insulate all bare speaker wires from each other and chassis ground
Unit blows fuse(s)	Yellow or red wire touching chassis ground	Check for pinched wire
	Speaker wires touching chassis ground	Check for pinched wire
	Incorrect fuse rating	Use fuses with correct rating
Unit has audio (but no video)	Parking brake safety circuit not connected Parking brake not applied	Check connections at parking brake Apply parking brake as described on page 26
	No video display (when in reverse)	Reverse circuit not connected Vehicle is not in reverse
DVD does not start playback	Physical defect in media Wrong region	Check media for scratches Use discs labeled "Region 1" or "All" only
IR remote does not work	Dead battery	Replace battery
Excessive skipping	Unit is not mounted correctly	Check mounting sleeve
	Physical defect in media	Check media for scratches
Disc Region Incorrect appears on display	Region code error	Use discs labeled "Region 1" or "All" only

For Your Records

Please keep your original sales receipt and be prepared to provide this receipt in the event you require service, as your original receipt is considered the best proof of purchase and indicates the date you purchased your Dual product.

Dealer Name _____

Dealer Phone _____

Purchase Date _____

Register Your Product

Register your product online at www.dualav.com.



Dual Electronics Corp.
Toll Free: 1-866-382-5476
Monday-Friday, 9AM-5PM EST

www.dualav.com
©2016 Dual Electronics Corp. All rights reserved.
NSA0916-V01
Printed in China