

# LUHSL20B

Installation & Owner's Manual

---



**Wireless Bookshelf Speakers  
with Smart Speaker Dock**



## What's in the box

**LUHSL20B - 1 PAIR**

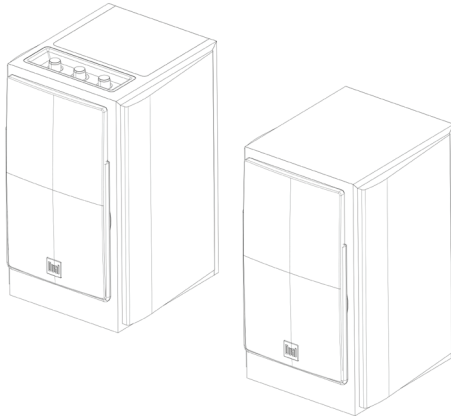

**CABLES**



Speaker connecting cable



3.5mm to RCA cable (AUX cable)

**USER MANUAL**





## Congratulations

On your **LUHSL20B** Bluetooth wireless speakers purchase. Please take your time to explore all of the features and utilities we have built into this product.

We put all of our products through rigorous testing and quality control. We take great pride in presenting this product to you. For your peace of mind, we offer a one-year limited warranty against manufacturing defects and workmanship. Please refer to the warranty section of this user manual for more details.

### SUPPORT

For the latest information on all of our products:

- Visit [www.dualav.com](http://www.dualav.com)
- Call us toll-free at 1-866-382-5476
- E-mail us at [cs@dualav.com](mailto:cs@dualav.com)

All rights reserved. No part of this publication may be reproduced, distributed, or transmitted in any form or by any means, including photocopying, recording, or other electronic or mechanical methods, without the prior written permission of DUAL ELECTRONICS CORP.

All trademarks and trade names are property of their respective owners.  
Copyright © 2024 DUAL ELECTRONICS CORP.



The Bluetooth® word mark and logos are registered trademarks owned by Bluetooth SIG, Inc. and any use of such marks is under license.

**IMPORTANT USER SAFETY INFORMATION**

The lightning flash with arrowhead symbol within an equilateral triangle is intended to alert the user to the presence of unisolated, dangerous voltage within the device that may be of sufficient magnitude that may pose a risk of electric shock.



**WARNING:** To reduce the risk of electric shock, do not remove cover or back plate. There are no user-serviceable parts inside. Refer servicing to qualified personnel.



The exclamation point within an equilateral triangle is intended to alert the user to the presence of important operating and servicing instructions in the literature accompanying the device.

## USER INFORMATION

### FCC COMPLIANCE

This device complies with part 15 of the FCC Rules. Operation is subject to the following two conditions:

- (1) this device may not cause interference, and
- (2) this device must accept any interference, including interference that may cause undesired operation of this device.

This transmitter must not be co-located or operated in conjunction with any other antenna or transmitter. The Bluetooth antenna cannot be removed (or replaced) by user. This equipment complies with FCC/ IC radiation exposure limits set forth for an uncontrolled environment and meets the FCC radio frequency (RF) Exposure Guidelines and RSS-102 of the IC radio frequency (RF) Exposure rules. This equipment has very low levels of RF energy that it deemed to comply without maximum permissive exposure evaluation (MPE). But it is desirable that it should be installed and operated keeping the radiator at least 20 cm or more away from person's body (excluding extremities: hands, wrists, feet and ankles). Alteration or modifications carried out without appropriate authorization may invalidate the user's right to operate the equipment.

NOTE: This equipment has been tested and found to comply with the limits for a Class B digital device, pursuant to Part 15 of the FCC Rules. These limits are designed to provide reasonable protection against harmful interference in a residential installation. This equipment generates, uses and can radiate radio frequency energy and, if not installed and used in accordance with the instructions, may cause harmful interference to radio communications. However, there is no guarantee that interference will not occur in a particular installation. If this equipment does cause harmful interference to radio or television reception, which can be determined by turning the equipment off and on, the user is encouraged to try to correct the interference by one or more of the following measures:



#### CAUTION!!

**ADJUSTMENT OR ALTERATIONS OF THIS DEVICE MAY RESULT  
IN HAZARDOUS RADIATION EXPOSURE.**



# LUHSL20B - Safety Information

## SAFETY ADVISORIES

1. READ all safety and operating instructions before using this product.
2. KEEP all safety and operating instructions for future reference.
3. READ and understand all warnings listed in the operating instructions.
4. FOLLOW all operating instructions to use this product.
5. **WARNING:** To reduce the risk of electric shock, do not expose the speakers to rain or moisture, This product should not be used near water, i.e., bathtub, sink, swimming pool, wet basement, etc.
6. Only use a dry cloth to clean this product.
7. **DO NOT** place this product near any heat sources such as radiators, heat registers, stoves or other apparatus (including amplifiers) that produce heat.
8. Protect the power cord from being walked on or pinched, particularly at plugs, convenience receptacles, and the point where they exit from the apparatus. **DO NOT** remove the ground pin from the power supply cord.
9. Unplug the speakers during lightning storms or when unused for a long period of time.
10. Care should be taken so that objects do not fall on the unit and liquids are not spilled into the unit or any other openings.
11. Refer all servicing to qualified service personnel. Servicing is required when the amplifier has been damaged in any way.
12. When a main plug or an appliance coupler is used as the disconnect device, the disconnect device shall remain readily operable,
13. **DO NOT** plug any input jack from the amplifier directly into any output connection on the same amplifier, for risk of damage to the amplifier.



## AVIS DE SÉCURITÉ

1. LIRE toutes les consignes de sécurité et d'utilisation avant d'utiliser ce produit
2. CONSERVEZ toutes les instructions de sécurité et d'utilisation pour vous pouvoir reporter ultérieurement.
3. LISEZ et comprenez tous les avertissements indiqués dans le mode d'emploi.
4. LIRE toutes les instructions d'utilisation pour utiliser ce produit.
5. **AVERTISSEMENT** : Pour réduire le risque de choc électrique, ne pas exposer cet appareil à la pluie ou à l'humidité. Ce produit ne doit pas être utilisé à proximité de l'eau, c.-à-d. baignoire, évier, piscine, sous-sol humide, etc.
6. Utilisez uniquement un chiffon sec pour nettoyer ce produit.
7. **NE PAS** placer ce produit à proximité de sources de chaleur telles que radiateurs, grilles de chauffage, cuisinières ou autres appareils (y compris les amplificateurs) produisant de la chaleur.
8. Protégez le cordon d'alimentation de sorte qu'on ne puisse pas marcher dessus ou le pincer, en particulier au niveau des prises de courant, et du point de sortie de l'appareil. **NE PAS** retirer la broche de terre du cordon d'alimentation.
9. Débrancher cet appareil pendant les orages ou lorsqu'il n'est pas utilisé pendant une longue période.
10. Veiller à ce que des objets ne tombent pas sur l'appareil et à ce que les liquides ne soient pas renversés dans l'appareil ou dans toute autre ouverture.
11. Adressez-vous à un personnel d'entretien qualifié. Un entretien est nécessaire lorsque l'amplificateur a été endommagé de quelque manière que ce soit.
12. Lorsqu'une fiche principale ou un coupleur d'appareil est utilisé comme dispositif de déconnexion, le dispositif de déconnexion doit rester facilement utilisable.
13. **NE** branchez AUCUNE prise d'entrée de l'amplificateur directement dans une connexion de sortie sur le même amplificateur, car cela risquerait d'endommager l'amplificateur.

# Dual LUHSL20B - Features

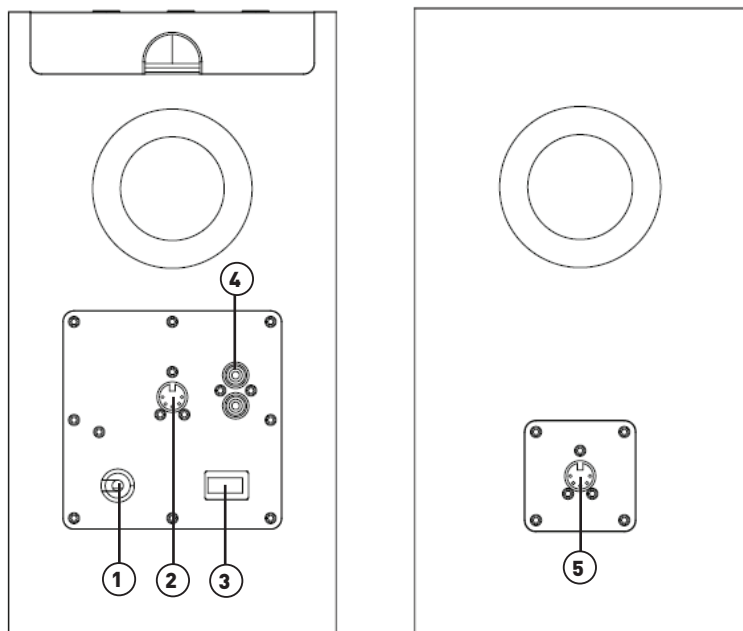

1. Power Plug
2. Left Speaker Output
3. Power Switch (On/Off)
4. Auxiliary Input
5. Left Speaker Input



# LUHSL20B - Remote Control

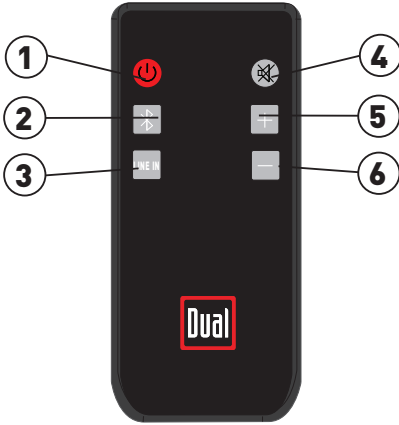

1. Power
2. Bluetooth On/Off
3. Line In / AUX Input
4. Mute
5. Volume Up
6. Volume Down

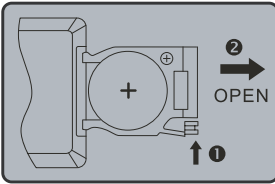

## Battery loading:

Please refer to the illustration to open the battery compartment, insert the CR 2025 battery and close the compartment.

1. Do not place the remote control in places that are hot and humid.
2. Do not charge the batteries.
3. Remove the batteries when unused for long period of time.
4. The battery should not be exposed to excessive heat such as direct sun or fire.

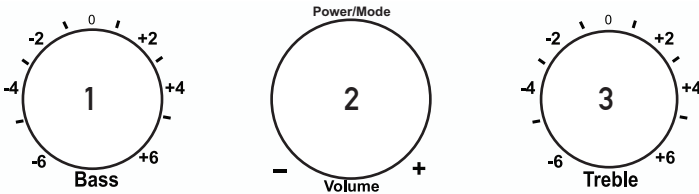
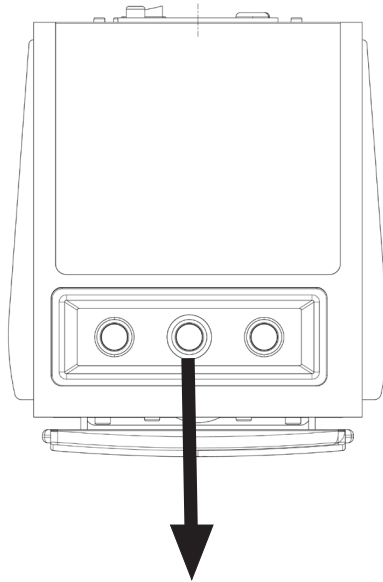

### MAIN CONTROL PANEL

- 1. Bass Adjustment** - Press the Bass button down to release the knob for easier adjustment, then rotate left or right to adjust the Bass settings (-6dB to +6dB). Press the Bass button down when finished.
- 2. Power/Mode / Volume Adjustment** - Press and hold for three seconds to turn Power On or Off. Rotate right or left to increase or decrease volume levels. Press briefly to switch to Bluetooth mode.
- 3. Treble Adjustment** - Press the Treble button down to release the knob for easier adjustment, then rotate left or right to adjust the Treble settings (-6dB to +6dB). Press the Treble button down when finished.

# LUHSL20B - Wireless Operation

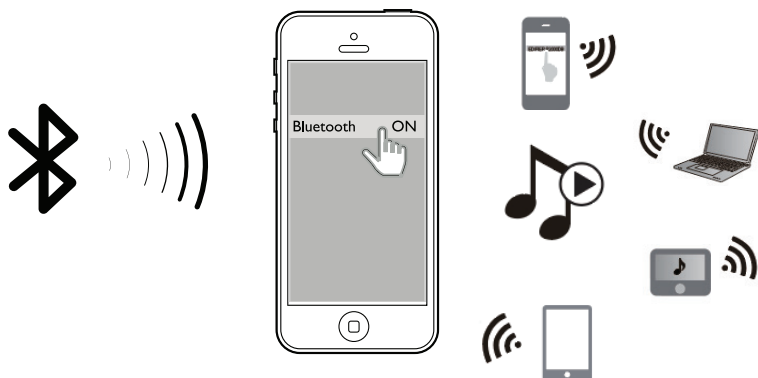

1. To connect to Bluetooth, turn the power switch on the speakers, then press and hold the Power button on the top of the active speaker or the Bluetooth button on the remote control until the LED indicator turns blue.
2. Turn on Bluetooth on your mobile phone, tablet or MP3/MP4 player to search for Bluetooth devices, and select "LUHSL20B" from the list of devices found.
3. Pair your device with the LUHSL20B speakers.
4. Play audio from your paired device and adjust the volume to a desired level.

**Note:** If the volume appears low, adjust the volume settings on your device to MAX.

5. To disconnect from Bluetooth, press & hold the power button on the top of the active speaker.

## Notes:

1. Bluetooth connectivity and compatibility may differ between different source devices depending on software versions.
2. To enjoy the full Bluetooth functions of this product, please ensure your mobile device has A2DP profile.
3. PIN code for connection is "0000" if needed.



# LUHSL20B - Speaker Connections

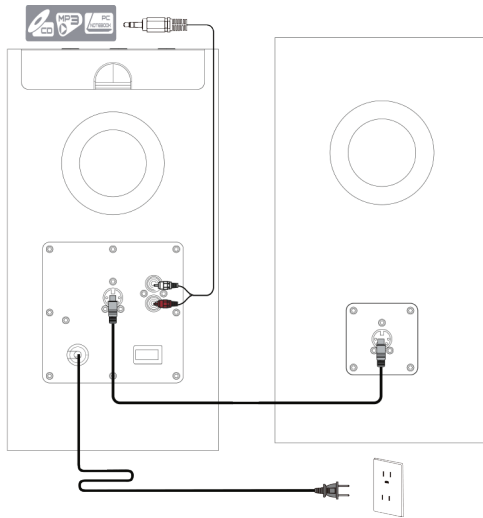

## SPEAKER PLACEMENT

### Speaker Placement

Your **LUHSL20B** speakers can also be placed in many convenient locations in your home or patio area.

### Experiment for Better Sound

You should experiment with various placements. Room acoustics can produce large apparent differences in the sound when small changes in the placement are employed.

For example, although the speaker may be located at any height above the floor, angling the entire speaker toward the listening position often provides the most realistic imaging experience. The amount of bass perceived increases as you move the speakers closer to solid intersecting room surfaces (walls, ceiling, floor).

## TROUBLE SHOOTING

PROBLEM	SOLUTION
No sound	Switch the speakers off, then reconnect the audio device.
	Make sure the master volume control knob on the top is turned up.
	Ensure the audio input is connected and that the input is set correctly on the speakers
	Ensure there is a signal from the audio source.
Cannot connect via Bluetooth	Ensure Bluetooth functionality is enabled and compatible on your Bluetooth device.
	Move the device closer, and retry the connection.
	Try another Bluetooth device for connection
Unit does not power on	Check to ensure power is connected and wall outlet is switched on.
	Switch the system off, then on, and reconnect to the audio source.

## SPECIFICATIONS

### BLUETOOTH

- BT: 5.4
- BT Range: 33Ft / 10M (Class 2)
- BT Profiles: A2DP / HFP

### GENERAL

- Frequency response: 65Hz-20kHz
- Woofer: 5.25" (133mm) Polypropylene with Rubber Surround
- Tweeter: 1" (25mm) Silk Dome
- Sensitivity: 85 dB
- Nominal impedance: 4 Ohms
- Power handling: 100 Watts
- Dimensions: 285\*198\*172mm(H\*D\*W)
- Color: Cherry/Black



# LUHSL20B - Warranty

## Warranty Coverage

You must have proof of purchase to receive warranty service. Please keep your original sales receipt and be prepared to provide this receipt in the event you require service, as your original receipt is considered the best proof of purchase and indicates the date you purchased your Dual product.

## For Your Records

Model \_\_\_\_\_

Dealer Name \_\_\_\_\_

Dealer Phone \_\_\_\_\_

Purchase Date \_\_\_\_\_

Note: You may want to keep your original sales receipt or a photo copy with this owner's manual.

## SUPPORT

- Call us toll-free at 1-866-382-5476.
- E-mail us at [cs@dualav.com](mailto:cs@dualav.com).



# LUHSL20B - Warranty



## LIMITED TWO-YEAR WARRANTY

This warranty gives you specific legal rights. You may also have other rights which vary from state to state.

Dual Electronics Corp. warrants this product to the original purchaser to be free from defects in material and workmanship for a period of two years from the date of the original purchase.

Dual Electronics Corp. agrees, at our option, during the warranty period, to repair any defect in material or workmanship or to furnish an equal new, renewed or comparable product (whichever is deemed necessary) in exchange without charges, subject to verification of the defect or malfunction and proof of the date of purchase. Subsequent replacement products are warranted for the balance of the original warranty period.

**Who is covered?** This warranty is extended to the original retail purchaser for products purchased from an authorized Dual dealer and used in the U.S.A.

**What is covered?** This warranty covers all defects in material and workmanship in this product. The following are not covered: software, installation/removal costs, damage resulting from accident, misuse, abuse, neglect, product modification, improper installation, incorrect line voltage, unauthorized repair or failure to follow instructions supplied with the product, or damage occurring during return shipment of the product.

Specific license conditions and copyright notices for the software can be found via [www.dualav.com](http://www.dualav.com).

### What to do?

1. Before you call for service, check the troubleshooting guide in your owner's manual. A slight adjustment of any custom controls may save you a service call.
2. If you require service during the warranty period, you must carefully pack the product (preferably in the original package) and ship it by prepaid transportation with a copy of the original receipt from the retailer to an authorized service center.
3. Please describe your problem in writing and include your name, a return UPS shipping address (P.O. Box not acceptable), and a daytime phone number with your shipment.
4. For more information and for the location of the nearest authorized service center please contact us by one of the following methods:

- Call us toll-free at 1-866-382-5476
- E-mail us at [cs@dualav.com](mailto:cs@dualav.com)

**Exclusion of Certain Damages:** This warranty is exclusive and in lieu of any and all other warranties, expressed or implied, including without limitation the implied warranties of merchantability and fitness for a particular purpose and any obligation, liability, right, claim or remedy in contract or tort, whether or not arising from the company's negligence, actual or imputed. No person or representative is authorized to assume for the company any other liability in connection with the sale of this product. In no event shall the company be liable for indirect, incidental or consequential damages.

Dual Electronics Corp.  
Toll Free: 1-866-382-5476  
Monday-Friday, 9AM-5PM EST  
[www.dualav.com](http://www.dualav.com)

©2025 Dual Electronics Corp. All rights reserved.

NSC1024-V01



**Dual**

---